



ISSN: 2230-9926

Available online at <http://www.journalijdr.com>

IJDR

International Journal of Development Research
Vol. 13, Issue, 10, pp. 63967-63971, October, 2023
<https://doi.org/10.37118/ijdr.27320.10.2023>



RESEARCH ARTICLE

OPEN ACCESS

LIGHT'S VELOCITY

*Leonard Van Zanten

Essay, 5428 Bushnell ave, USA

ARTICLE INFO

Article History:

Received 11th July, 2023
Received in revised form
28th August, 2023
Accepted 16th September, 2023
Published online 28th October, 2023

KeyWords:

Light. Velocity. Radial. Wavelength.

*Corresponding author:
Leonard Van Zanten

Copyright©2023, Leonard Van Zanten. This is an open access article distributed under the Creative Commons Attribution License, which permits unrestricted use, distribution, and reproduction in any medium, provided the original work is properly cited.

Citation: Leonard Van Zanten, 2023. "Light's Velocity". International Journal of Development Research, 13, (10), 63967-63971.

ABSTRACT

This essay as part two of an essay entitled; "Red Shift into Radial Velocity." Shows how the computations currently used for radial velocities are in error, and for an understanding of the correct computations it is imperative to understand the nature of light and how it travels.

INTRODUCTION

We established light in wavelengths that in the optical length vary from roughly 7000^Å to 4000^Å. And that the shorter lengths are found to travel by a velocity relative for distance in time at a speed less than those of the longer lengths. How therefore can there be only a singular velocity for light? -- For the fact that the speed of light varies according to their respective lengths - is ample proof that there is a constant in velocity whereby it comes to the many relative velocities. When we specify a vacuum velocity meant for space, it should, or must have a reference to one of some 3000 optical lengths. But we at all times fail to specify those lengths. If we base our amplitude at 1.5415^Å it is the red 7000^Å length that computes to a velocity of 299.792-km/sec. (The so-called vacuum speed of light.) Wherefore my diameter of 1.5415^Å is not arbitrarily taken. But it shall hardly be a constant when it varies with each and every wavelength that in the optical range as mentioned amounts to 3000 different lengths. Will we therefore have 3000 different constants of? We would do better to have our velocity to an average, like 299.736-km/sec based on 5500^Å, (4000^Å at 299.637- km/sec.) And so what is c, at 299.792- km/s (as the notation for light in space) when 299.637-km/s shows itself for the average of all? Nor with all this are we anywhere near to understanding light in its movement as it shows itself to be compressed and/or expanded in the varied densities by which it travels. By illustration Figure 1, speaking of waves - as were they lengths - the red 7000^Å wave as it is taken to pass in space has its angular deviation from zero to 3500^Å (broken line) since of course it spans but once around the circular.

If then into glass it is compressed by an index of 1.52 the length is reduced to 4605^Å. (Solid line) This compression with an even distribution shows the angular from zero to 1514^Å with a full turn in the circular at 3029^Å. And by advancing another 1514^Å comes to 4542^Å from which it continues to 4605^Å. We came to our new 4605^Å length by taking 7000^Å into the index of 1.52. And while previously there was but a single turn, this has now become 1.52 of a turn, identical to the index.

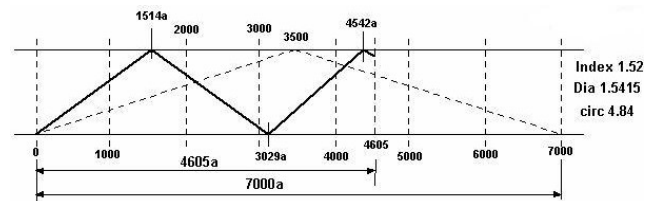

Figure 1. Illustrating the compression of a wave into glass while retaining its length and by the index of that glass. Typically, this is not according to observations that light travels by lengths, but it is to serve as a comparison next to what is real in light

The red color of the wave that we previously equated at 3500^Å, has now moved backwards to 1514^Å. What therefore should that compressed wave appear unto us for color? A full length of 3028^Å is something that would normally be found for violet, or out of our optical range. Or what will that shift show upon a spectral plate? Normally we would call it by an angle of 4605^Å, or by a half measure, while in fact it comes to an angular of no more than one-third of the

compressed wave. The compression forced the 7004.84^{A} long length into more than a single turn around the circumference. In this case - since the index to retardation was 1.52, it came to 1.52 times around, as it shifted to the new length, 7000^{A} to 4605^{A} . The angle in its movement however, which before stood at 3500^{A} has now been reduced to 1514^{A} . An interesting prospect so I say, how also the crest-to-crest measure from 7000^{A} has come to 3029^{A} . In all respects light for its movement is not anywhere near as simple as we beheld it to be. If the identity of a wave is held as its length, then by entering into the denser media of glass it did indeed maintain its identity seeing how it recovered the same in exiting. And of course it's RELATIVE velocity slowed since simply said the wave within the glass is making more time in place. It for all of its 300.000-km/sec to travel a distance of 7004.84^{A} in the now new length of 4605^{A} slowed it down FOR DISTANCE IN TIME.

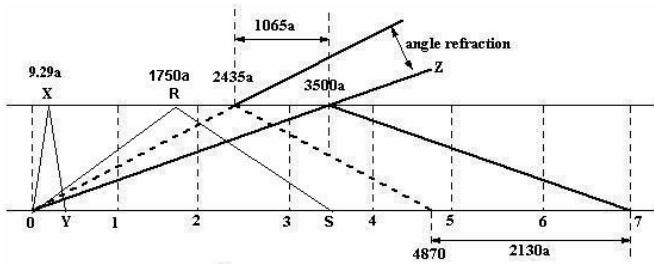

Figure 2. Wavelength Reduction by 90/KM/SEC

By figure 2 from 0 to 7 is the length of a red $7000a$ wavelet (solid line) that when reduced by a velocity of 90/km/sec comes to a full length of $4870a$, (Broken line) with the half-length to $2435a$. When thus it shows an angle to refraction, it is never more than what it shows at its half-length, no angle in refraction can ever be shown by any full length. Full lengths are found in the realm of mathematics, not in reality, all because a wave is an angular moment, an indent or code by an angular deviation. The physical length also of any wavelet need not be what it shows mathematically, it can be no more than a quarter of it - because it is an angular moment on the move. Nor is it self-sufficient but driven by the ever fundamental movement in nature at the tune of 300.000/km/sec, never more, never less. But we are not at yet home since our space velocity of 299.792-km/s into the index of 1.52 came to a reduction in velocity at 197.231-km/s, - and to what wavelength does that apply? It applies to the wavelength that was found by the index, the length of 4605^{A} . Previously in our discussion we found that the hydrogen wave of 4861^{A} red shifted to 4923^{A} - that then as it came upon our atmosphere by the index of air at 1.0003, blue shifting to 4921^{A} - was in error in that a mere 2 angstroms cannot account for 90-km/s, forcing us call the index of 1.0003 to err when it is used for wavelength. Here however in this case with the entry into glass the index does seem to be somewhat correct.

How thus can it seem to work here but not previously? It is because here we are using a comparable wavelength. For in taking the full angular length of 7004.84^{A} to be divided into the 300.000, and then multiplied by the new length found by the same index at 4605^{A} , it comes to 197.220-km/sec, which is fairly close to 197.231-km/s. This however was not previously the case, in that we used the one of 4861^{A} , as quoted to us. That particular length then must be an altered length, or else the index does not really work for wavelength - but only for velocity. For if we took our 7000^{A} length assuming it were a 6000^{A} length, to come upon the glass, a 6000^{A} wave travels at 299.758-km/sec, and that into the index of 1.52 comes to 197.209-km/sec. If then we apply the index to wavelength, 1.52 into 6000^{A} is 3947^{A} , which as such comes to a velocity at 197.190-km/sec, a difference of 19-km/sec. If on the other hand we assumed it as a 7000^{A} length altered to 6000^{A} , its velocity at the 3947^{A} wavelength would come to 169.040-km/sec, a difference of 28.169-km/sec. The conclusion here is that the index does not work for wavelengths, but for velocity. Some of our differences may be in the amplitude, that it should be somewhat more or less, but that is not my fault. It was not me to set the space velocity at 299.792-km/s without specifying as to what wavelength that applied. And for that failure of man I used the longest of lengths, the one at 7000^{A} , that then provided me with the

proper amplitude. (diameter) But now that we have tinkered with light as full waves in lengths just to see what that is like, we must now apply ourselves to a new reality, that lengths have their forthcoming by nothing other than the calculus, and that they as such are never real. Whereas the angular moments travelling by a three dimensional concept are the only real thing with light as well as with any wave. And for this I will adapt what is commonly held for light, namely, that it travels by "Discrete Bundles of Energy." Myself I may have this by a different term as 3W, but that detail is in one of my previous pages. If thus we wish to call them photons, I will humour man, the reality however are coordinates of movement. When we implement a wave, we as such are driving a discrete amount of energy (movement) by an angle into a linear path. As then for the example we are working on the atomic level - the diameter in which these bundles are driven into a circumference will come to something on the order of 1.5415^{A} .

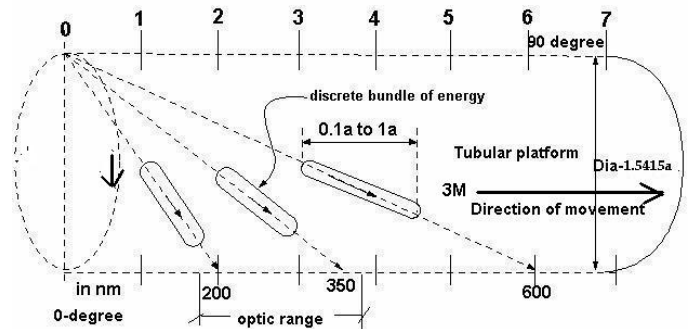

Figure 3. Wave production in the angular

By the illustration, figure 3, if the photon is driven in an angle from 0 to 200, the length by which that coordinate must pass to make for a single full turn will come to 400-nm. (Our blue color wave in a crest-to-crest measure) While for the red color it must be in an angle from 0 to 350 to compute to its 700-nm length. Or from zero to 600 the full length would be 1200-nm. The angle then in which these coordinates (as the better term for photons) are produced can be anywhere from zero to 90 degree. A zero angle, heading straight down at right angle to the direction of movement, would come to a zero wavelength, nor therefore can that be a wave on the move. And at 90 degrees it would a straight line and again no wave on the move. But by an angle anywhere in between the waveforms are born.

And how do these come to their various angles? It's quite simple, when we heat a metal bar it first turns reddish, meaning the slow angles, or long lengths are produced. Then as more and more heat is applied, the internal movement of the atoms increase to greater speeds, by which the induced angles becomes sharper and sharper, with the lengths of the waves decreasing. Or to put it another way, when the speed by which a pulse is initiated is rather high the consequent angle by which it is forced into the circular is naturally sharper, away from the 90 degree, for while this pulse in the circular takes place it is upon the ever magnetic movement, like placing it upon a moving band - with a velocity of 300.000-km/sec. It is for that reason that the photon comes to its angular movement. If on the other hand the speed of that rotating inducement is rather slow, it comes to a minor angle that translates into a longer length. Therefore when we super heat something to become while hot, the higher velocity is forcing the photons at their right angle movement at a higher or more forceful rate, by which of course the angles become more acute, whereby then the length in their once around the circle decreases proportionally.

And so we may have gathered that it is all in movement, and by rates of movement, movement producing movement. Nor is it only by heat that this takes place, even though heat is a rate of movement, but by any means that the rates of velocity can be brought about into an oscillation whereby waves may be produced. What then shall the compression or expansion be upon any such wave, if not to simply change the angle at which it travels? We must remember how our illustration here for its diameter verses length is far out of proportion,

and I do believe that for any angle there are several cut-off points, one near zero degrees, with the other near 90 degrees. At zero degrees there is no wave, and at 90 degrees it is a straight line. When the angle comes to the 350-nm line, the length of the wave becomes 700-nm and travels at the speed of 299.972-km/sec. If the angle comes to 30-nm, the length of that wave will be no more than 60-nm, the velocity comes to 297.599-km/sec. If we compare this to a 600-nm length the velocity of which is 299.758-km/sec, the difference between these two is 2159-km/sec. The reduction in velocity here is because - while the photon completes but a single rotation in the 600-nm length, the one of 60-nm must complete 10 turns in order to advance itself by the same distance. Ten times its circumference is 4.84-nm plus ten times the 60-nm in length is 648.4-nm. This in comparison to the 600-nm length was an angular length of 600.484-nm. In that 600-nm distance - while one made one turn with the other ten turns it had a negative radial velocity of 2159-km/sec. That then can be calculated any way we wish, by ones or by tens. But we cannot compare velocities of waves that travel by a different circular diameter, on one and the same diameter. The diameter of radio waves cannot be used for light, nor even for microwaves. Within any circular diameter from x rays on down to long waves we must abide by that 90 degree of a circle by and in which all its waves are formed. In a division there are a possible of 9000 different angular lengths. Number 9000 then is a straight line, while number one is a zero length. My emphasis here with this illustration is to get us away from waves as waves in lengths, or in lengths altogether other than finding them mathematically - with our reality on discrete amounts of whatever that may be, photon, 3W, or energy as simple movement. And how these all in themselves by the ever magnetic constant come to lengths by and in which the relative velocity of all waves may be found mathematically. As then the mystery will remain what these bundles are, and how long or how short these may be, your guess is as good as mine. I noted one of these from 0.1^A to 1^A , but for all reality they may be longer and/or wider. I frankly do not know other than that such things of such or other nature is what makes light and all other types of movement in contrast.

How therefore do all these and other pieces of the puzzle fit together whereby light for its velocity as well as for its movement may be fully known? If indeed we are utilizing a wrong amplitude, how much should that be if we were to take our space velocity, so well known at 299.792-km/sec, as the average velocity of the 3000 possible velocities?

The average from 4000 to 7000 is 5500, by which our amplitude would then be reduced to 1.2^A . For here taking a 1.2^A into the circumference we arrive at 3.8^A . And that added to 5500 comes to 5503.8^A that then divided into the constant of 300.000, multiplied by the nominal length of 5500^A , brings us again to our 299.792-km space velocity. That space velocity of old thus - to which no length was given - is now based on the 5500^A wavelength. For it makes no sense that when 3,000 events arrive at 3,000 different velocities to state that these moved with a single velocity. Nor so I must say, can we even speak of a single velocity as were it a constant when there are 3000 of them, each one different from the other. And again since in fact these are different from one another - they as such are not any sort of constant, but relative velocities, speeds relative to distance in time. At no time should any sort of velocity that shows itself to be relative, be called or taken for a constant. If this cannot be understood as factual in nature, we are in sad shape. For all that I have spoken now in the way of light - I am on the right track for its mode of travel, but I cannot as yet guarantee a single set velocity, neither in the relative nor in the constant. I am merely testing and experimenting if somehow I can come to a conclusion whereby all the pieces of the puzzle fit perfectly together. We have the evidence in nature that light is compressed as well as expanded, and that it refracts according to the angle of its own waveform with velocity a by-product. And how by measurements its speed for distance in time varies not only by any change in density but for wavelength as well. Wherefore it stands to reason that there is a different angle of movement by which these different lengths come to their varied velocities. Yet how do we put all this together - for angular moment to an index of - so that by any

and all calculations everything matches perfectly? I have made a start, but that is all that I have done.

What is Light?

If we ask our scientists and physicists what light is, the answer will be that it consists of photons. If then we ask what a photon is, the answer is - that it is a discrete package of energy. Since then energy in all essence is motion, light must be a discrete movement passing angularly along a linear path. This may be envisioned by something of an immaterial nature moving forward along the design of a coiled spring, one that in all respects is far stretched, seeing how for each single turn in that coil the length is many times greater to its width. It however cannot be envisioned as any kind of particle on the move, nor therefore a photon if that photon is to be considered a particle. Even a thin sheet of foil reflecting light - presents us with ample evidence that light cannot consist of anything so material - how for the speed at which light is known to travel - it would pass through that foil without ever knowing it was there. Light now for its nature of is 'A MOVEMENT IN CONTRAST.' If then indeed I have hit the nail squarely upon its head, these words in themselves do not do it justice. And so bear with me as I attempt to explain myself. The whole of nature consist of two basic things. A statement that is not altogether true, but for our purpose, and for what is allowed unto us - it as such is correct. The first is movement noted as 3M, and understood by us as magnetic or magnetism, with the second as tiny points or dots in nature known as atoms. That movement then is everywhere always and it proceeds by what is best known as lines of. And these lines always proceed by a circle, a never-ending circle that is laid over by a half wave formation into a pattern that resembles the figure of eight. Conclusively we are speaking of magnetic, be it in general as magnetism, or in force, or field of. And it as such is one of the most fundamental forces in nature. It then is immaterial, meaning its nature in contrast to what we understand as material - is immaterial. For here while we look upon things as material or immaterial, these in all reality are but figures of speech. For while our automobile appears to be material with the air immaterial, the air is as material as the automobile. And likewise with the 3M, it also is material, as in existing, having a being, but in relation to the atom for a material something the 3M movement as such is immaterial.

There is something we must understand about motion. When an airplanes moves in the sky its movement as such is displacement, it is not an entity, nor energy on its own. That movement as an energy or power is in conjunction with the plane, not therefore on its own. The 3M however is a motion and power on its own, an entity in itself. A vehicle on the road has energy or power only when it moves. Here too that motion is as displacement and not an entity other than in conjunction with the vehicle. The movements of the plane, and of the vehicle, is not something we refer to as immaterial, even though it is altogether immaterial, it being nothing other than displacement. The 3M on the other hand as an entity is rated and thought of as being immaterial.

But that immaterial is so in relevance to all that we behold for being material: For when we start speaking fundamentally that immaterial 3M becomes a material something even as the atoms are. We might compare it to ourselves in our bodies as being material while the air through which we move - in relevance to our bodies appears immaterial. And while all this in the fundamental scope may be difficult to comprehend, I can go no further without crossing a threshold that I in the wisdom given me have set for myself. Let it thus be as I have said, and do not think to fantasize upon it, for it will be in error. Now I hope to have explained myself well enough in the how of these two things, one rated material, with the other immaterial. And if so, we can go forth to enumerate what light is and how it comes about. Let us thus take our standard light bulb, a novelty where with electricity upon a tungsten element light is produced. Reference figure 4. The electricity as it passes upon these atoms and molecules invokes a push pull scenario that among other things results into a heating of the element.

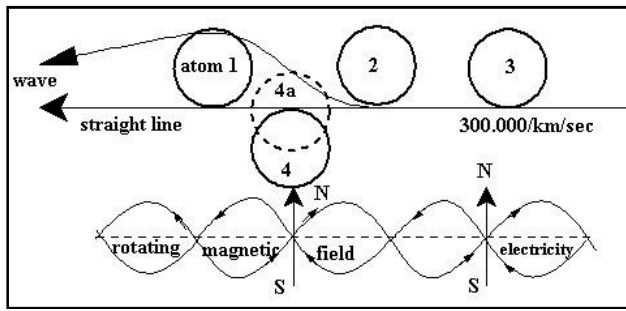

Figure 4. Light in/and by our standard light bulb

That heating is simply a higher degree of movement causing the atoms to spin faster whereby they attempt to expand their fields of force. In conjunction with this, an imbalance is set up which I termed RAM, that not only means; Relative Angular Movement, but is in fact a so called fluctuating movement in angular's relative to one another. (Man terms it as exited). All that movement then in the angular occurs while the parts rotate, wherefore there are two primary innovations, number one is the circular movements, and that coupled with number two, the angular fluctuations. The latter in conjunction with the first then induces as one might say - dents around the circular that are taken away by the always present and always moving 3M, the magnetic flow. And to illustrate this by figure 5 there is the always-moving 3M, at a straight line. Then at point 'A' the exited atoms being pushed back and forth at specific timings in their rotations intercepted by the push-pull inflict pulses into the angular around the circular atomic movement that as such becomes a deviation (B) upon the straight line of movement. That deviation then is not just a dent or indent that we might inflict upon a string or a cable, a two dimensional concept, but it is three dimensional, an angular indent that goes around a circular force and or movement of. In other words, around the atoms, which are rotating entities having a field of force.

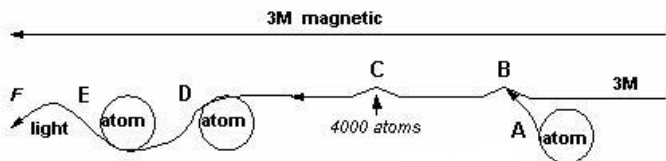

Figure 5. Illustrates a wave for an angular deviation into a straight line of movement passing in the circular

And so that indent is taken away in the circular fashion around all the atoms in its path that for its direction of is in a straight line, indicated by D, E, and F. As therefore we consider anyone of these indents by itself like at C, that little indent is a full wavelength to span itself over 1000 to 4000 or more atoms. B and C, in the illustration are two dimensional, while D, and E are to illustrate its three dimensional concept by which all magnetic waves have their movement, light being one of those. And so what is light, if not a movement by contrast?

A straight line does not present a contrast, but any twist or circular, or so-called dent upon it presents a contrast, a variance that can be read at any distance from its point of origin. Since thus there are two factors with light, the atoms for their movement, and the 3M for its movement, light is a movement by and of them in contrast to that which is straight. Is then light an immaterial something? We could give it a yes, since the 3M, as we previously looked upon is immaterial. But it is also a no, as in not really, since the atoms by which it was induced, and by which it proceeds, are reckoned for being material. And that angular something in itself may also be something of a nature that is of both or neither. Light therefore in all respects appears to us as I began to say; "A movement in contrast." And when these three dimensional movements strike the back of our eye, or any surface, these in all essence trace a circle upon it, a moving circle, a force to induce circular movement upon whatever it may be struck. That is how and why electricity may be gained from light falling upon our solar panels, and how light instigates movement upon all plants for the growth of it.

Examples

Now that we seem to have a good understanding in how light travels and how radial velocities are to be calculated, we have as yet to hear the full of it. Below is a Radial Velocity chart, highlighting five readings. The first column shows the radial velocity obtained by man in his calculations. The second column shows the change in wavelengths. The third column shows the real velocities of the first noted lengths of the waves. The fourth column shows the velocities of the expanded waves. The fifth column then shows the true and correct radial velocities.

Radial Velocity chart

Radial velocity	Cal- K in A	V of Normal length	V of Shifted length	V Radial
0-km/sec	3933 to 3968	299.631-km/s	299.634-km/s	35 = 3-km/s
100-km/sec	3934 to 3969	299.631-km/s	299.634-km/s	35 = 3 km/s
1000-km/sec	3946 to 3981	299.632-km/s	299.635-km/s	35 = 3 km/s
10.000-km/sec	4064 to 4100	299.643-km/s	299.646-km/s	36 = 3 km/s
274.000-km/s	6560 to 6620	299.778.82-km/s	299.780.82-km/s	40 = 2 km/s

Notice how it is but 3-km/s in all from the zero all the way up to 10.000, while the difference in the expansions are 35^A. The last one on the list however is the one that is really out of bounds, a radial velocity of no more than 2-km/s that is interpreted into some 274.000-km/s. But I wish to draw your attention to the expansions in the shifts verses the radial velocities. For each of the 35^{0A} in wave expansion there was an increase of 3-km, while the one with the greater expansion of 40^A came to only a 2-km increase. And why may that be so? The answer is - because it is a longer length, and as the lengths are greater and greater so the increase in their lengths must be greater to account for the same value in velocity.

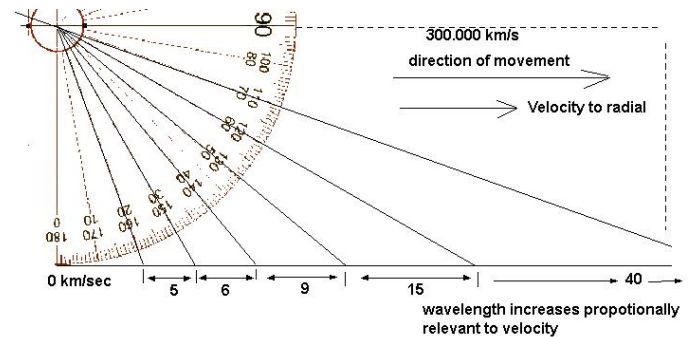

Figure 6. Illustrates the manner by which all waves are induced, and how in consequence thereof the lengths of wave increase

It's quite simple really as demonstrated by Figure 6. If the angular moment in the light is shifted from 20 to 30 degrees there are (for the example) 5 points expansion. From 30 to 40 degrees it becomes 6 points. And to increase the angle by another ten degrees it becomes 9 points. Where then from 50 to 60 degrees there are 15 points, another ten degrees will multiply that to 40 points. When therefore a receding object pulls on a wave by some 20-km/sec, if it were among the shorter ones like at 50 degrees, it must expand the wave more than if it were one at 30 degrees. And that expansion in the wave becomes greater and greater for the longer lengths just to keep up with the receding velocity. And so it becomes obvious how any shift in wavelength is never directly proportional to the change in velocity. Yet we are quite able to determine the correct relative velocity of any wave as long as it is computed by its three dimensional format. (Vc : Awl x Nwl) And for this we need the correct diameter of the wave into its circumference that varies for each octave of the spectrum. By the "Comparison chart," is an example of length verses velocity. Notice when a blue color wave is expanded by 40^A, it required a 3.6-km/s velocity. The same expansion by an 8000^A wave came to only

0.9-km/s. At 6800^a a 200^a expansion comes to 6.1-km/s, while at 8000^a a 200^a comes to 4.4-km/s. The longer the wave the more velocity it takes to expand it by the same amount.

Comparison chart. (4.84a circumference)

1:	4000 to 4040a	299.637.4 km/s to 299.641.0 km/s	= 40a = 3.6-km/s
2:	6800 to 6880a	299.786.6 km/s to 299.789.1 km/s	= 80a = 2.5-km/s
3:	6800 to 6900a	299.786.6 km/s to 299.789.7 km/s	= 100a = 3.1-km/s
4:	6800 to 7000a	299.786.6 km/s to 299.792.7 km/s	= 200a = 6.1-km/s
5:	8000 to 8040a	299.818.6 km/s to 299.819.5 km/s	= 40a = 0.9-km/s
6:	8000 to 8200a	299.818.6 km/s to 299.823.0 km/s	= 200a = 4.4-km/s

Calculating wave r/velocity: (R), Relative velocity for the waves of the spectrum is their velocity for distance in time. And to discover that velocity mathematically, here is the simple means to it.

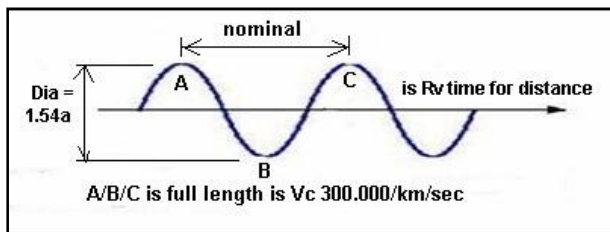

Figure 7. Wave velocity calculation

The nominal length of any wave is the linear distance of any crest to crest measure. The actual length is its full and true distance of that measure together with its measure in circumference. When therefore we add the circumference to the nominal length, and divide that by the velocity of constant. (The true velocity of its movement) and multiply this by the nominal length we will always come up with the correct relative velocity of any and all waves.

By example; a 500-nm wave = 300.000 : 5004.84 = 59.9etc X 5000 = 299,709.9-km/s. For the sake of clarity and reality it is imperative that we do away with our so called space velocity (c) to rate it as no more than a relative velocity with the addition to what length of the wave it applies. If thus we can accurately measure the speed of light by a single fixed wavelength, we will then be able to determine the precise amplitude in a full diameter.

CONCLUSION

All waves of nature's magnetic spectrum are produced by an angular momentum that then is taken away by the ever-magnetic movement that rates an unwavering velocity of 300.000-km/sec. The variations in these angular movements for incidence as well as circumference is what computes into lengths and frequencies, as well as the relative velocities of each of these. The nomenclature of these angular moments is a mystery that for the time being may be referred to as discrete amounts of energy, be it photons, 3W, or simply a movement at contrast.
